

# DOMINATOR 750 MAINTENANCE SHEET - HOW TO ASSEMBLE

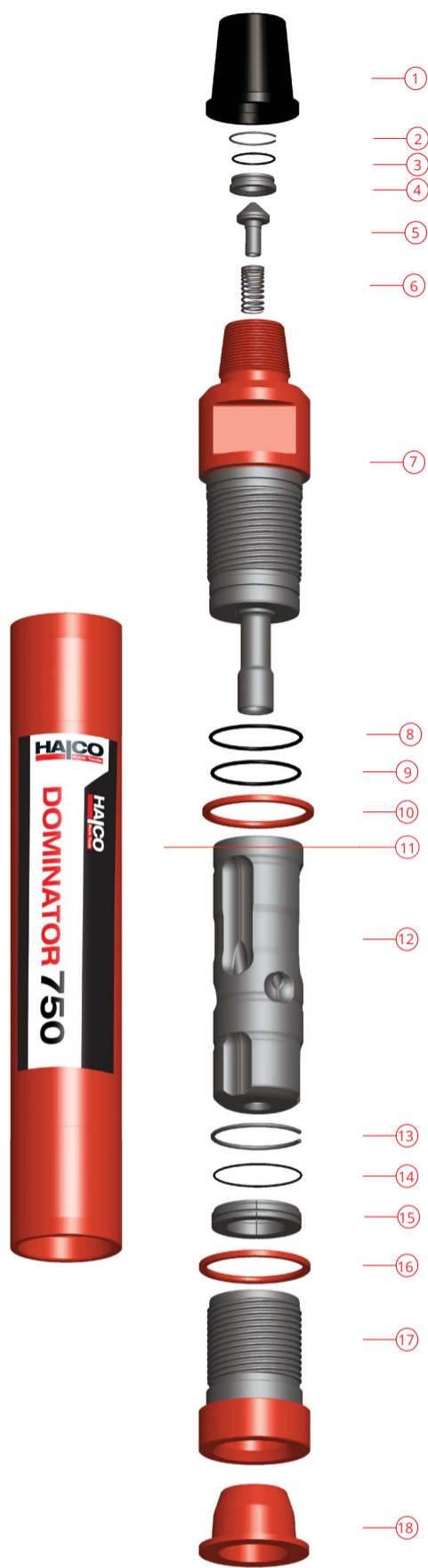

**A.** Before assembly ensure that all components are cleaned, greased and lubricated. Lay out components in the order of the illustration above for ease of identification.



**B.** Secure Cylinder (11) on a bench or suitable stripping equipment. The cylinder has two identically positioned snap ring grooves and is reversible.



**C.** Insert Snap Ring (13) into bottom of Cylinder (11). Ensure it sits in the snap ring groove.

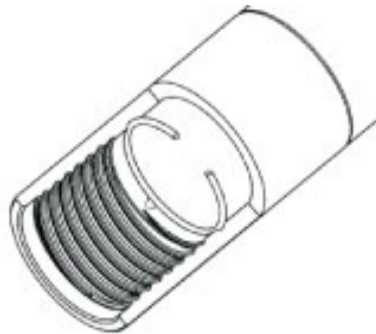

**D.** Grease splines and fit Chuck (17) over the Drill Bit.

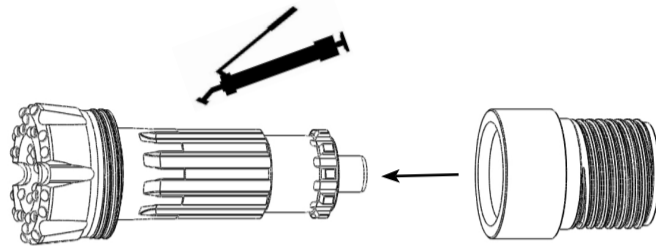

**E.** Fit Chuck Spacer (16) over Chuck (17) and place the Bit Retaining Ring (15) onto the Drill Bit.

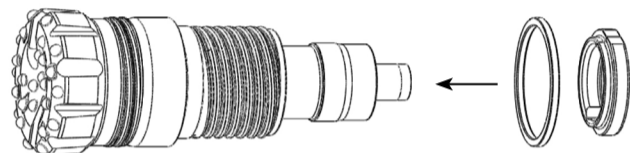

**F.** Grease threads and screw the Drill Bit, Chuck (17), Chuck Spacer (16) and Bit Retaining Ring (15) into the bottom of the Cylinder (11) until fully tightened.

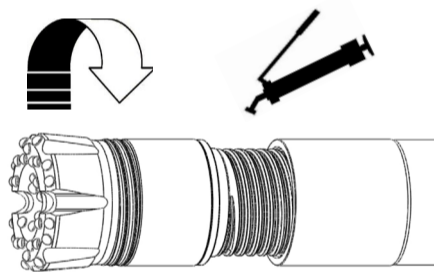

**G.** Coat the Piston (12) liberally with rock oil, minimum 200 centristroke and insert into the top of the Cylinder (11). Ensure it is facing the right way as illustrated.

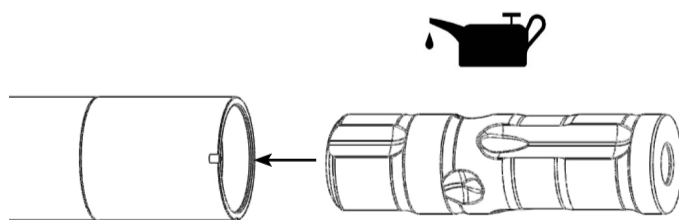

**H.** Fit Spacer (10) onto the Top Adaptor (7). Fit O'Rings (8 & 9) onto Top Adaptor (8). Ensure they sit in the O'Ring grooves.

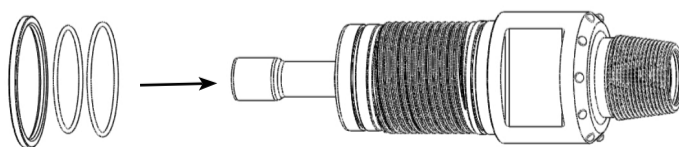

**I.** Grease threads and screw the Top Adaptor (7) and Spacer (10) into the top of the Cylinder (11) until fully tightened.

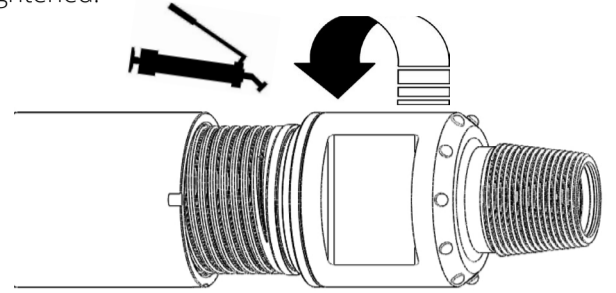

**J.** Fit 'O' Ring (3) onto N.R.V. Seat (4). Ensure it sits in the 'O' Ring groove.

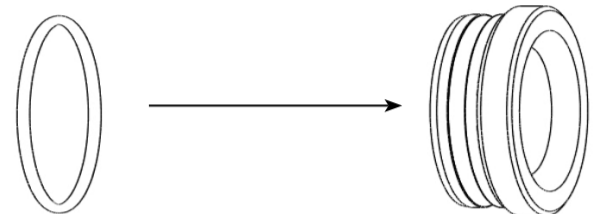

**K.** Insert N.R.V Assembly (3-6) into the Top Adaptor (7).

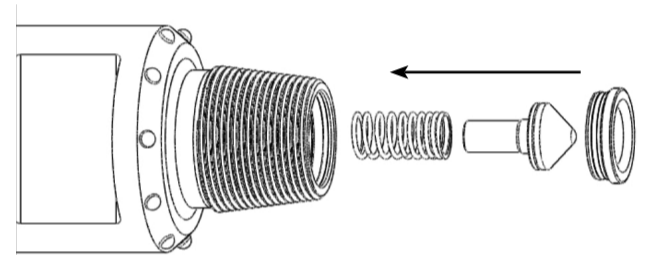

**L.** Insert Snap Ring (2) into the Top Adaptor (7). Ensure it sits in the snap ring groove.

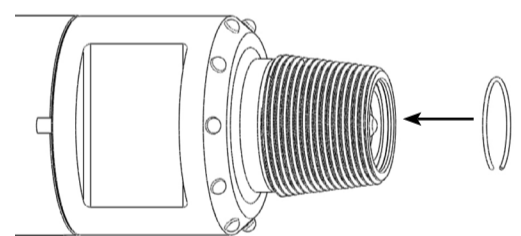

**M.** Depress N.R.V. (5) and pour 1/3 litre of air line oil into the hammer.

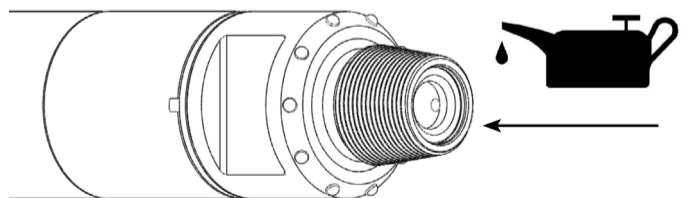

If you need further assistance, please call us on:  
(0)1422 399900 or email [salesuk@halcorocktools.com](mailto:salesuk@halcorocktools.com)

**HAJCO**  
Rock Tools

# DOMINATOR 750 MAINTENANCE SHEET - HOW TO DISMANTLE

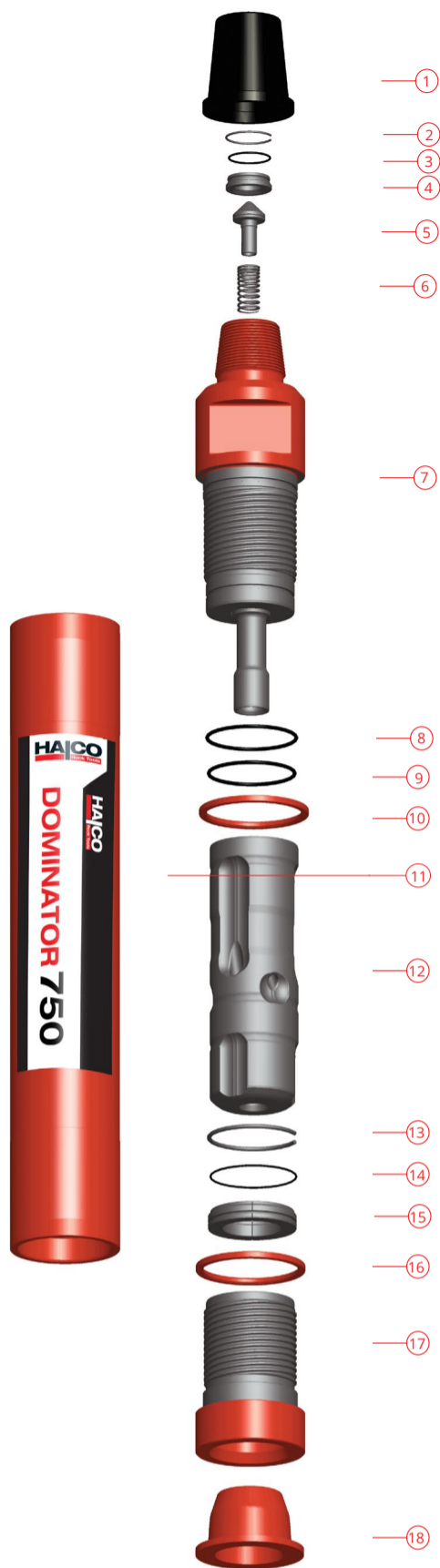

**B.** Break the top joint between the Cylinder (11) and Top Adaptor (7) and bottom joint between Cylinder (11) and Chuck (17).

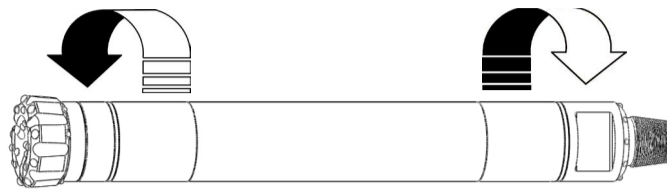

**G.** Remove the Piston (12) from the bottom of the Cylinder (11).

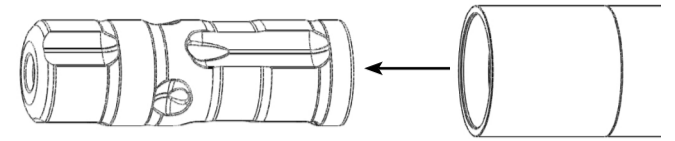

**C.** Unscrew and remove the Drill Bit, Chuck (17), Chuck Spacer (16) and the Bit Retaining Ring (15) from the Cylinder (11).

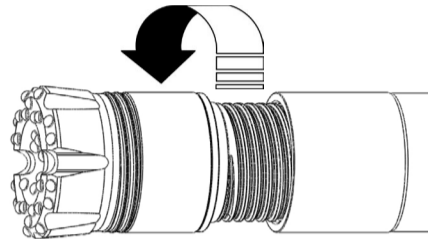

**H.** Remove the Snap Ring (2) from the Top Adaptor (7).

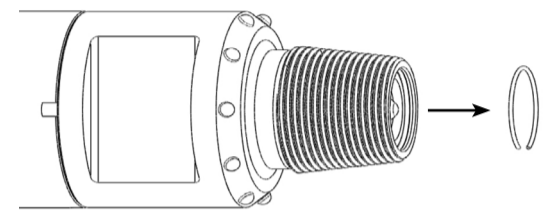

**D.** Remove the Chuck Spacer (16) from the Chuck (17). Remove Bit Retaining Ring (15) from Drill Bit and 'O' Ring (14) from the Bit Retaining Ring (15).

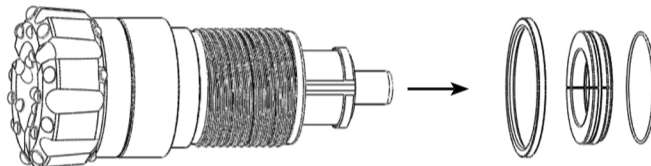

**I.** Remove the N.R.V. Assembly (3-6) from the Top Adaptor (7).

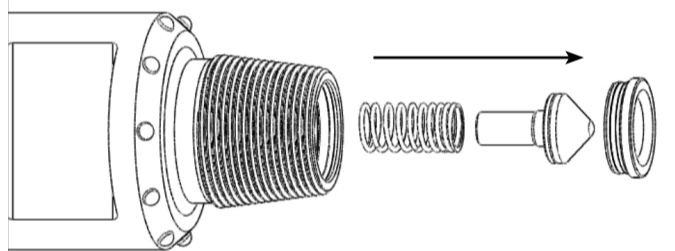

**E.** Remove the Chuck (17) from the Drill Bit.

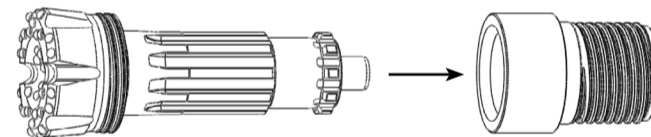

**J.** Unscrew and remove the Top Adaptor (7) and Spacer (10) from the Cylinder (11).

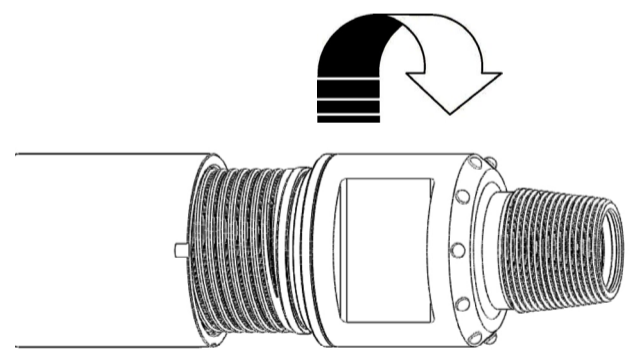

**DO NOT** apply heat or direct impact to the outside of the hammer as this usually damages the equipment.

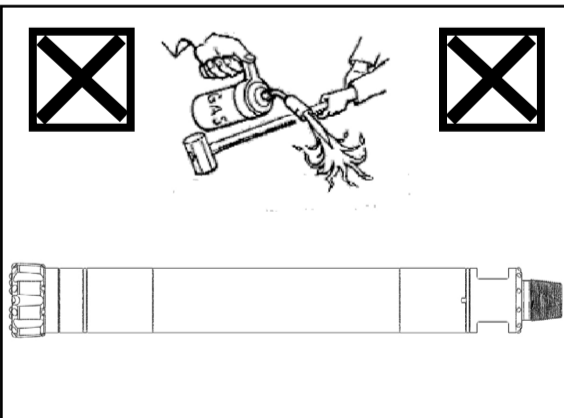

**A.** When dismantling hammers it is essential that cylinders are clamped in the correct position, away from threads, which can be damaged.



X & Y = DO NOT CLAMP HERE  
X = 250 mm (9.842")  
Y = 460 mm (18.110")

**F.** Remove the Snap Ring (13) from the Cylinder (11) using the tools illustrated below.

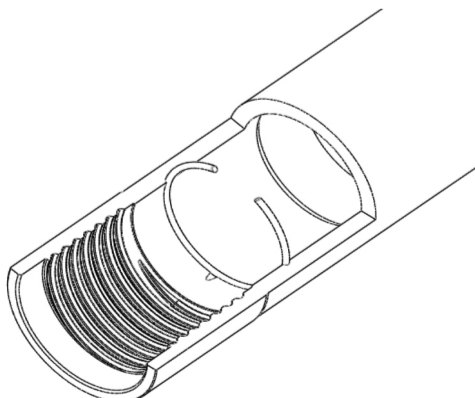
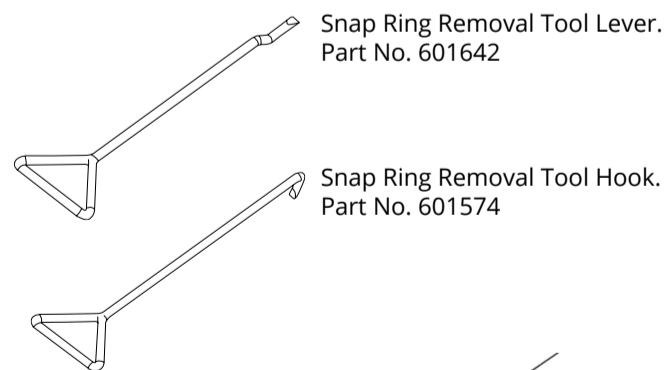

**K.** Remove the Spacer (10) and O'Ring (8 & 9) from the Top Adaptor (7).

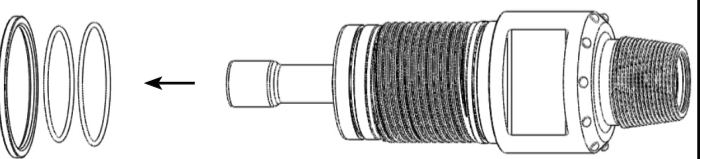

If you need further assistance, please call us on:  
(0)1422 399900 or email [salesuk@halcorocktools.com](mailto:salesuk@halcorocktools.com)